

---

STEREO  
POWER AMPLIFIER  
**ALPHA III**



**SERVICE MANUAL**

TYPE AND VOLTAGE

<b>W-TYPE</b> UL and CSA type	120V AC
<b>E-TYPE</b> NK-STD type	220/240V AC
<b>N-TYPE</b> DEMKO and SEMKO type	
<b>D-TYPE</b> DIN type	

**NIKKO**

## CONTENTS

Specifications . . . . .	2
Device Description . . . . .	2
Block Diagram . . . . .	3
Disassembly . . . . .	3, 4
Alignment . . . . .	4, 5
Schematic Diagram . . . . .	6
PC Boards . . . . .	7, 8
Parts Location . . . . .	9
Parts List . . . . .	10 ~ 13
Semiconductor Data	
Transistors . . . . .	14
Diodes, LEDs . . . . .	14
Zener Diodes . . . . .	14
Integrated Circuits . . . . .	15



# BLOCK DIAGRAM

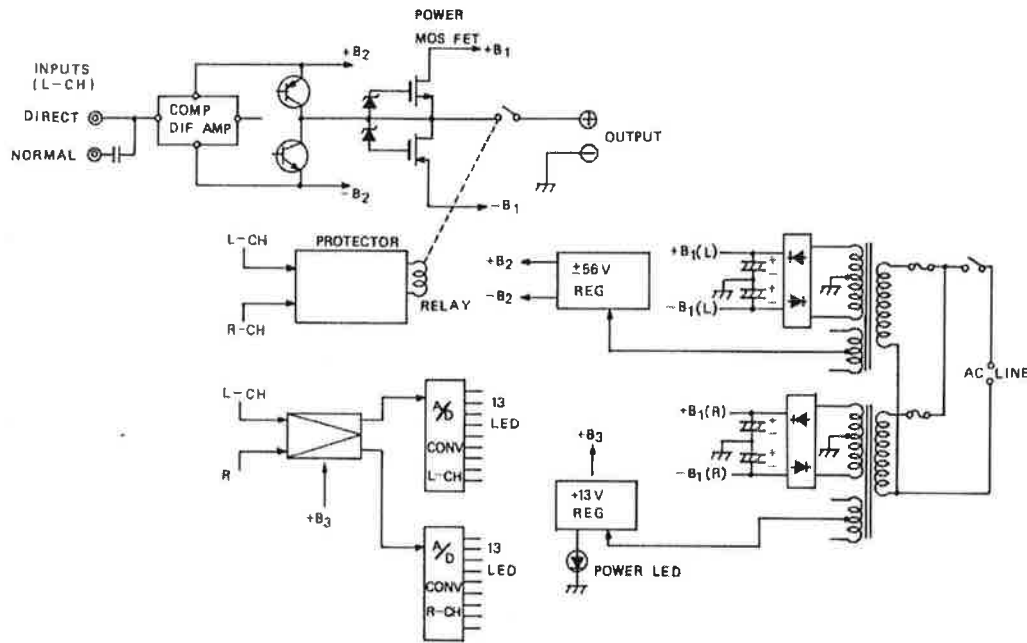

Figure 4. Block Diagram

## DISASSEMBLY

**WARNING:** When service is required, DO NOT alter or change any wiring or circuitry in this unit. Any modification other than the manufacturer's original may alter the specifications, such as distortion, stability, etc.

### CABINET COVER REMOVAL

Remove four tapping screws from the top of the metal cover. Remove four screws from both sides of the metal cover.

### BOTTOM PLATE REMOVAL

Remove ten tapping screws from the bottom of the unit.

### FRONT PANEL REMOVAL

1. Disconnect LED SOCKET (1A) from the LED mounted on the front panel by pulling it backward. (Photo 1)
  2. Remove POWER switch knob from the front of the unit.
  3. Remove six tapping screws (no.1-6) (Photo 2) and lift the panel away from the unit.
- To reassemble, reverse the procedure.

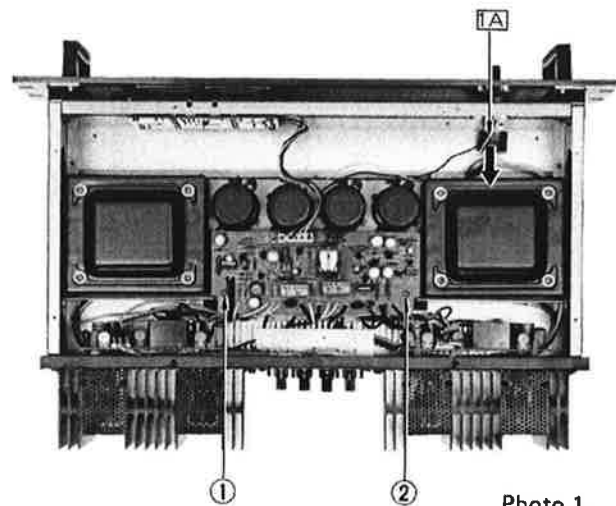

Photo 1.

### LEVEL INDICATOR ASSEMBLY REMOVAL

1. Disconnect connector (2A) deliberately in order not to break the regulator/protector PC board. (Photo 2).
  2. Remove the front panel. (Read "FRONT PANEL REMOVAL")
  3. Remove four tapping screws (no.1-4) (Photo 3) and lift the panel away from the unit.
- To reassemble, reverse the procedure.

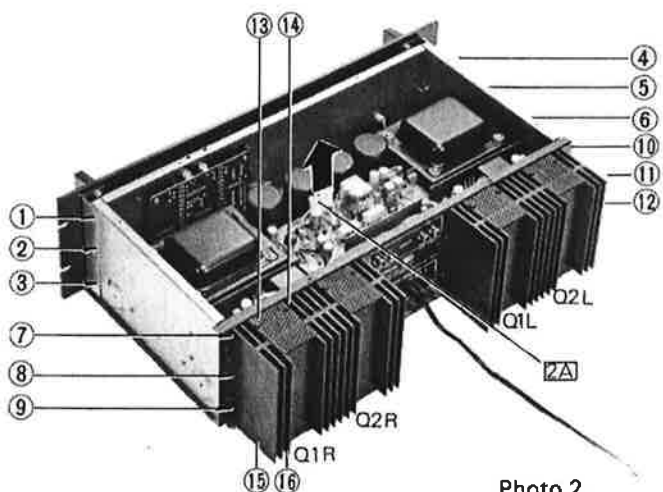

Photo 2.

### REGULATOR/PROTECTOR PART REPLACEMENT

1. Disconnect LED socket (1A) (Photo 1). (Read "Step 1, FRONT PANEL REMOVAL")

# SPECIFICATIONS

Semiconductors:	
IC's	3
Bipolar Transistors	18
FET's	4
Diodes	23
Zener Diodes	7
LED's	27
Continuous Power Output	80watts
(min. RMS, 8ohms, both channels driven, 20Hz to 20kHz, < 0.008% THD)	
Input Sensitivity	1V
(8ohms, 1kHz, 80watts output)	
Input Impedance (1kHz)	50kohms
Damping Factor	80
(8ohms, both channels driven, 1kHz)	
Signal to Noise Ratio (IHF A network)	115dB
Slew Rate	40V/ $\mu$ s
Mute Time	2 ~ 5s

Power Input:	
W-Type	120V AC, 60Hz
E-Type,N-Type,D-Type	220 or 240V AC, 50Hz
Power Consumption:	
W-Type	400watts (500VA)
E-Type,N-Type,D-Type	580watts
Dimensions:	
Width	19in. (492mm)
Height	5-7/8in. (130.5mm)
Depth	12-7/8in. (325mm)
Weight	35.2lbs. (16kg)

Specification subject to change without notice.

## DEVICE DESCRIPTION

The ALPHA III employs four power MOS FETs (2SK134, 2SJ49), which have the ideal characteristics of a power amplification device as follows:

1. Superior high frequency performance (figure 1)
2. Good breakdown capability  
The output characteristic curves at different case temperatures (shown in figure 2) indicate that when gate-to-source voltage ( $V_{gs}$ ) is constant, the increase of a case temperature causes the decrease of drain current ( $I_d$ ), therefore current concentration is at a minimum. For this reason, power MOS FETs have higher safe-area ratings than bipolar transistors. (figure 3)
3. High input impedance  
Power MOS FETs can be driven by less power owing to their high input impedance, therefore the driver stage can be simplified.

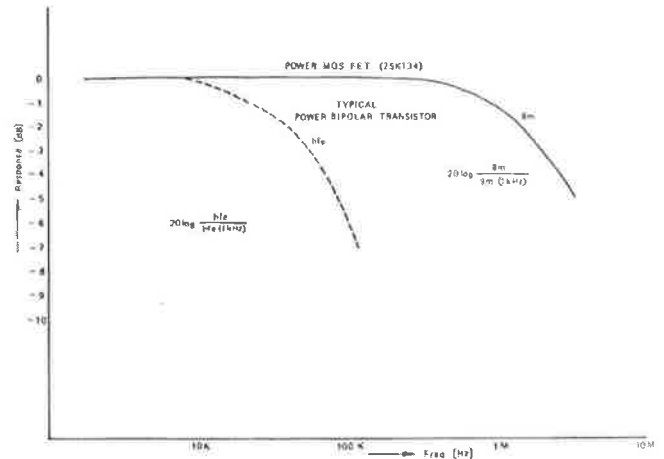

Figure 1. Frequency Response

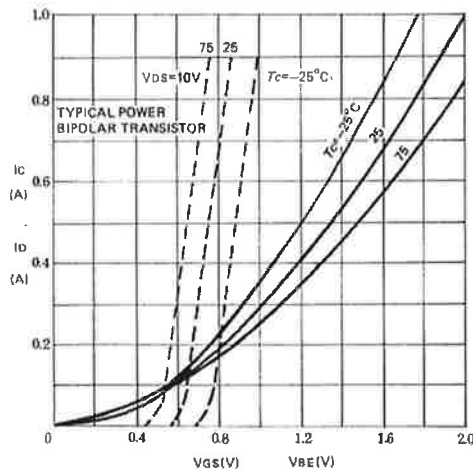

Figure 2. Output Characteristic

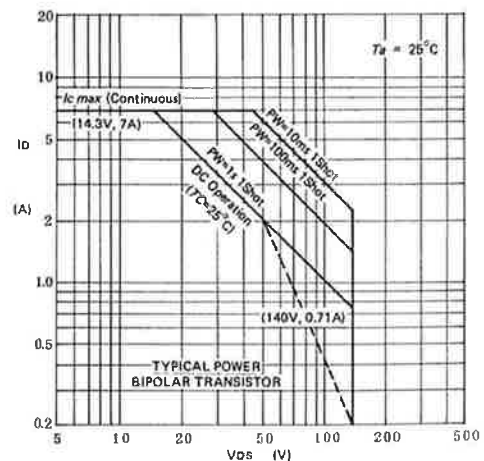

Figure 3. Area of Safe Operation

2. Disconnect connector (2A) (Photo 1).  
(Read "Step 1. LEVEL INDICATOR ASSEMBLY REMOVAL")
  3. Remove two tapping screws (no. 1,2) (Photo 1) and lift the front of the regulator/protector PC board for service. (Photo 4)
- To reassemble, reverse the procedure.

### MAIN AMP PC BOARD PARTS REPLACEMENT (LEFT CHANNEL ONLY)

1. Remove six tapping screws (no.7–12) (Photo 2) and tip the back plate assembly down as indicated in Photo 4.
  2. The main amp PC board is mounted in place by four plastic pins. Lift the top of the PC board up for service.
- To reassemble, reverse the procedure.

### POWER FET REMOVAL (Q1R ONLY)

1. Remove four tapping screws (no.13–16) (Photo 2) and remove the power FET cover.
2. Remove two screws holding the power FET and pull it out power transistor socket.

– To reassemble, reverse the procedure.

NOTE: When power FET is replaced, spread the power FET (and heat sink) with thermally conductive silicon grease.

### POWER SUPPLY CIRCUIT PARTS REPLACEMENT

The power supply circuit PC board is mounted in position by three plastic pins. Lift the rear of the PC board up for service.

### POWER TRANSFORMER REMOVAL (LEFT CHANNEL ONLY)

1. Disconnect all wires from the power transformer.

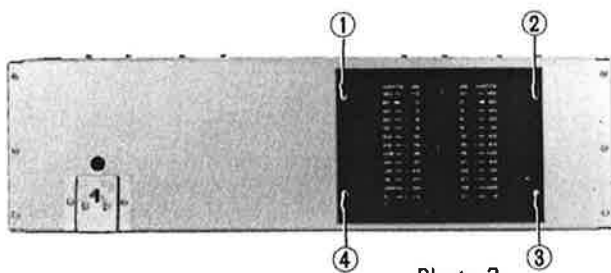

Photo 3.

2. Remove four nuts (no.1–4) (Photo 5) and lift the power transformer up and out of chassis.
- To reassemble, reverse the procedure.

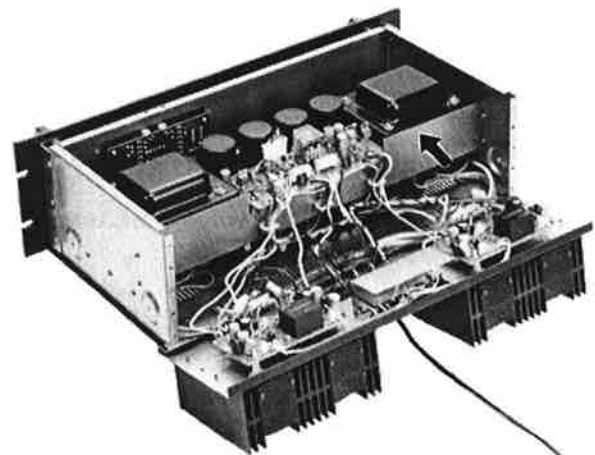

Photo 4.

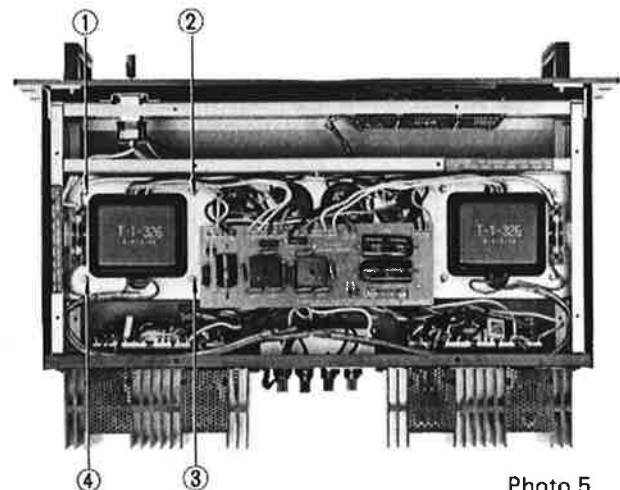

Photo 5.

## ALIGNMENT

### TEST EQUIPMENT

Allow a minimum of 10 minutes warm-up for test equipment.

Maintain rated line voltage.

Audio Frequency Generator

Distortion Meter

Oscilloscope

AC Voltmeter

DC Voltmeter

2–Dummy Load Resistor, 8 ohm, 250W

Connect 8 ohm dummy load resistors to left and right channel speaker terminals of the amplifier while except performing the protection circuit check.

### LEFT [RIGHT] CHANNEL MAIN AMP DC BALANCE ADJUSTMENT

NOTE: See illustration, Figure 5, for test equipment hook-up.

1. Connect DC voltmeter to test points 10 and 11 on left [right] channel main amp PC board.

2. Connect shorting pin plug to left [right] channel DIRECT input terminal. Adjust potentiometer R712 [R712] for a  $0 \pm 20$  mV DC voltmeter reading.
3. Disconnect shorting pin plug from left [right] channel DIRECT input terminal. With left [right] channel input terminal open-circuited, adjust potentiometer R703 [R703] for a  $0 \pm 20$  mV DC voltmeter reading.
4. Repeat steps 2 and 3 until both the reading become  $0 \pm 10$  mV.
5. Remove shorting pin plug. Remove DC voltmeter.

### MUTE TIME CHECK

Relay must operate two to six second later after AC power is turned on.

### LEFT [RIGHT] CHANNEL MAIN AMP IDLING CURRENT ADJUSTMENT

NOTE: See illustration, Figure 6, for test equipment hook-up.

1. Connect DC voltmeter to test points 9 and 10 on left [right]

channel main amp PC board.

2. With no signal applied to left [right] channel terminals, adjust potentiometer R721 [R721] for a 44.4 mV DC voltmeter reading.
3. Remove DC voltmeter.

### POWER DISPLAY CIRCUIT ADJUSTMENT

NOTE: See illustration, Figure 7, for test equipment hook-up.

1. Connect AC voltmeter, oscilloscope and distortion meter to left [right] speaker terminals. Connect generator to left [right] DIRECT input terminal.
2. Set generator frequency to 1 kHz. Set generator output for a 25.3V AC voltmeter reading. Adjust potentiometer R831 [R832] so that the lamp of 80W lights steadily.
3. Remove AC voltmeter, oscilloscope, distortion meter and generator.

4. The power level indicator characteristic is shown in Figure 8.

### PROTECTION CIRCUIT CHECK

NOTE: See illustration, Figure 7, for test equipment hook-up.

1. Connect AC voltmeter to left [right] speaker terminals. Connect generator to left [right] DIRECT input terminal.
2. Set generator frequency to 20 kHz. Set generator output for a 3.0V AC voltmeter reading. Short left [right] speaker terminals; Relay's contacts should open.
3. Set generator frequency to 15 Hz. Set generator output for a 25.3V AC voltmeter reading; Relay's contacts still close. Change generator frequency to 7 to 3 Hz; Relay's contact should open.
4. Remove all test equipment.

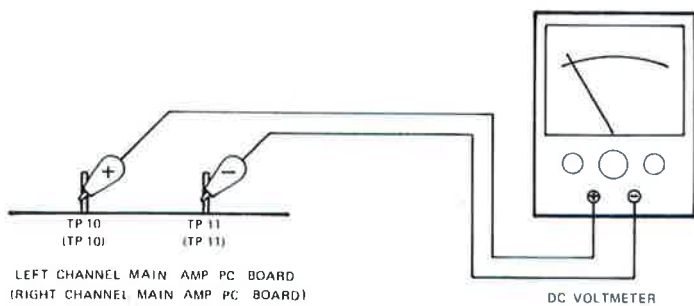

Figure 5. Test Equipment Hook-up

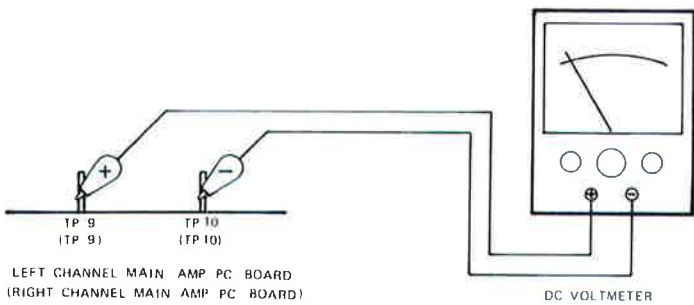

Figure 6. Test Equipment Hook-up

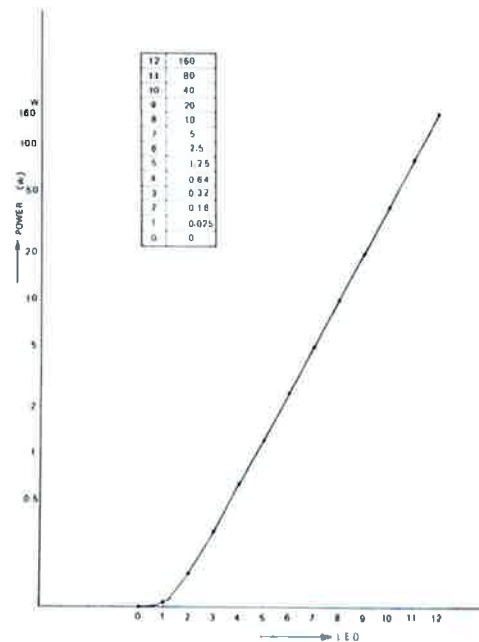

Figure 8. LED Power Level Indicator Characteristic

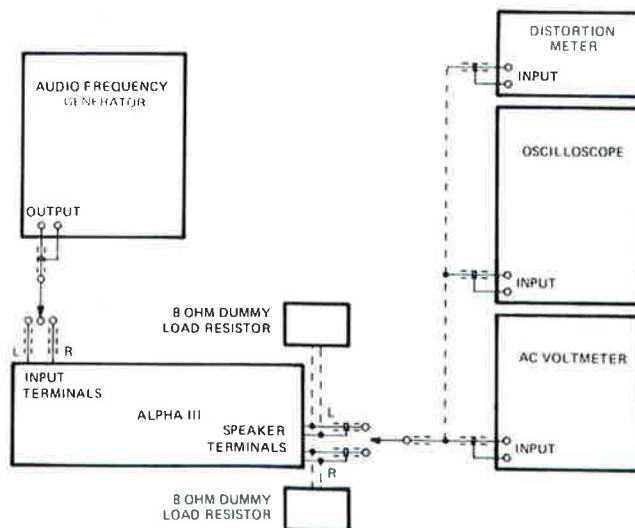
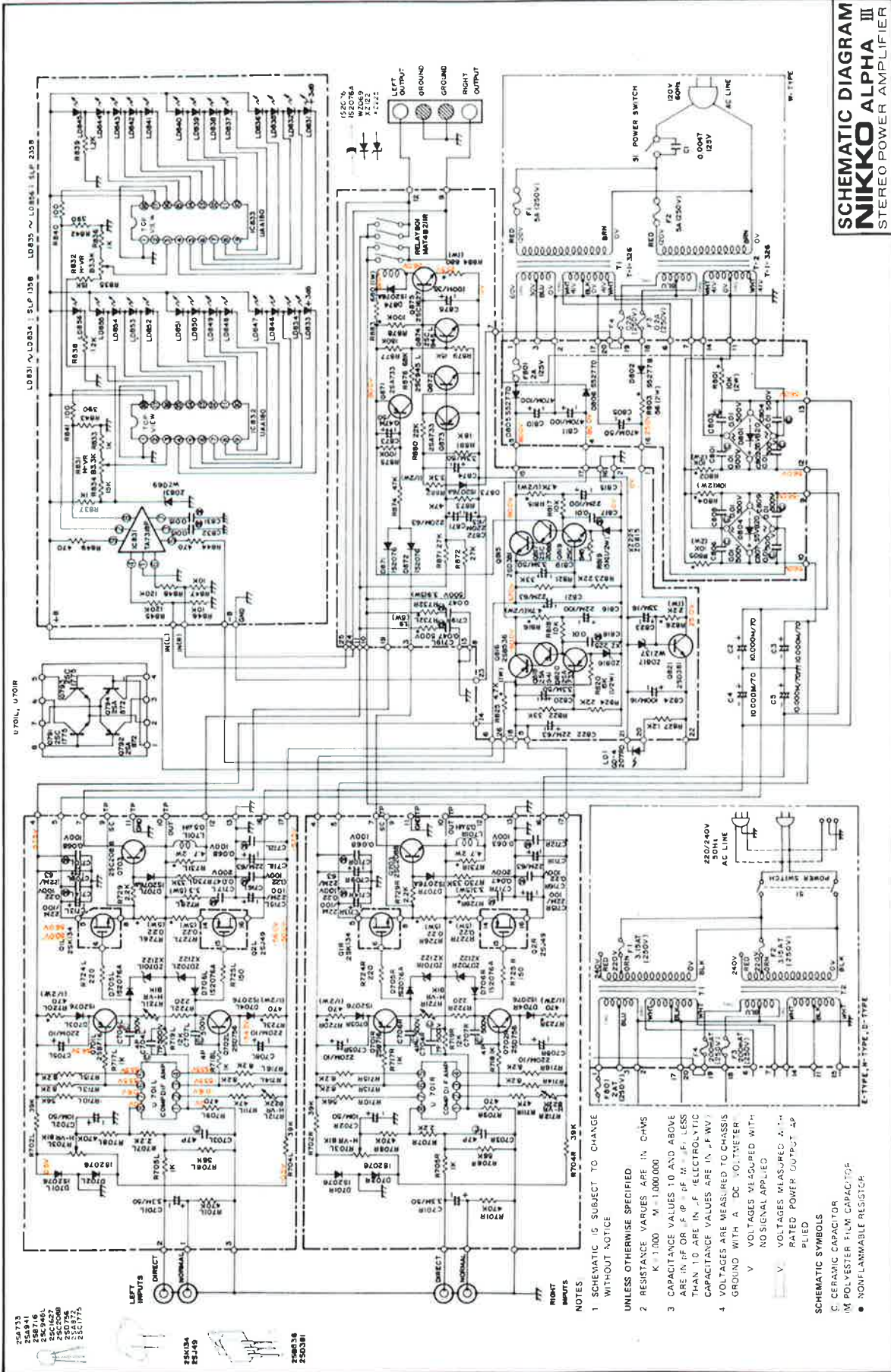

Figure 7. Test Equipment Hook-up



# SCHEMATIC DIAGRAM

## SCHEMATIC DIAGRAM NIKKO ALPHA III STEREO POWER AMPLIFIER



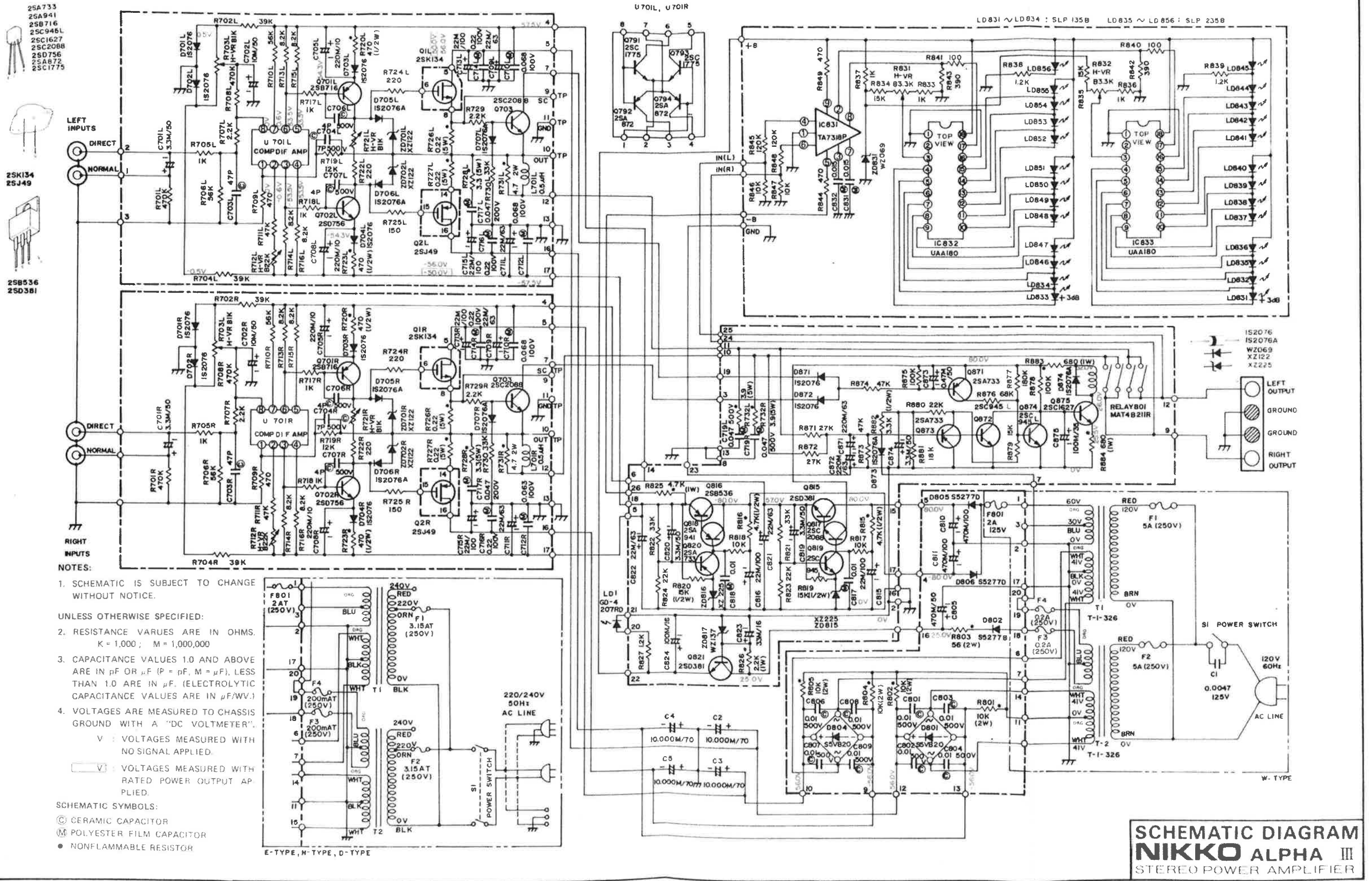

- 25A733
- 25A941
- 25B716
- 25C948L
- 25C1627
- 25D208B
- 25D756
- 25A872
- 25C1775

25KI34  
25J49

25B536  
25D381

LEFT INPUTS

DIRECT

NORMAL

RIGHT INPUTS

DIRECT

NORMAL

NOTES:

1. SCHEMATIC IS SUBJECT TO CHANGE WITHOUT NOTICE.
- UNLESS OTHERWISE SPECIFIED:
2. RESISTANCE VALUES ARE IN OHMS. K = 1,000; M = 1,000,000
3. CAPACITANCE VALUES 1.0 AND ABOVE ARE IN pF OR μF (P = pF, M = μF). LESS THAN 1.0 ARE IN μF. (ELECTROLYTIC CAPACITANCE VALUES ARE IN μF/WV.)
4. VOLTAGES ARE MEASURED TO CHASSIS GROUND WITH A "DC VOLTMETER".  
 V : VOLTAGES MEASURED WITH NO SIGNAL APPLIED.  
 V : VOLTAGES MEASURED WITH RATED POWER OUTPUT APPLIED.

- SCHEMATIC SYMBOLS:
- ⊖ CERAMIC CAPACITOR
  - ⊖ POLYESTER FILM CAPACITOR
  - NONFLAMMABLE RESISTOR

E-TYPE, M-TYPE, D-TYPE

**SCHEMATIC DIAGRAM**  
**NIKKO ALPHA III**  
 STEREO POWER AMPLIFIER



# PC BOARDS

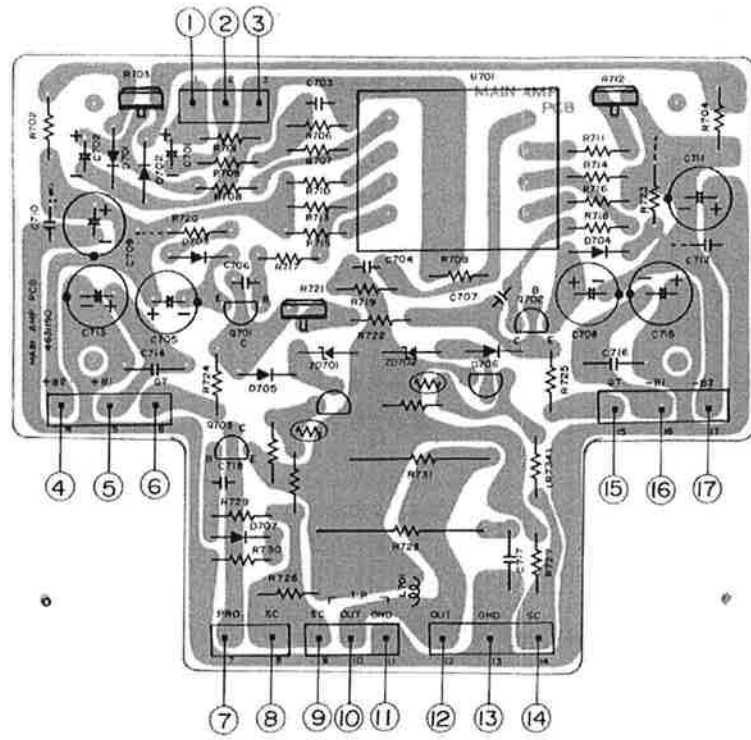

Figure 9. Main Amp PC Board (Bottom View)

## LEFT CHANNEL

- ① To L, NORMAL, INPUT TERMINAL
- ② To L, DIRECT, INPUT TERMINAL
- ③ To L(GROUND), INPUT TERMINAL
- ④ To 14, REGULATOR/PROTECTOR PC BOARD
- ⑤ To +, C2(10000MF, 70WV)  
To DRAIN, Q1L(2SK134)
- ⑥ To GATE, Q1L(2SK134)
- ⑦ To 9, REGULATOR/PROTECTOR PC BOARD
- ⑧ To SOURCE, Q1L(2SK134)
- ⑨ ⑩ ⑪ TEST POINTS
- ⑫ To 11, REGULATOR/PROTECTOR PC BOARD
- ⑬ To BUS BAR
- ⑭ To SOURCE, Q2L(2SJ49)
- ⑮ To GATE, Q2L(2SJ49)
- ⑯ To -, C4(10000MF, 70WV)  
To DRAIN, Q2L(2SJ49)
- ⑰ To 18, REGULATOR/PROTECTOR PC BOARD

## RIGHT CHANNEL

- ① To R, NORMAL, INPUT TERMINAL
- ② To R, DIRECT, INPUT TERMINAL
- ③ To R(GROUND), INPUT TERMINAL
- ④ To 16, REGULATOR/PROTECTOR PC BOARD
- ⑤ To +, C3(10000MF, 70WV)  
To DRAIN, Q1R(2SK134)
- ⑥ To GATE, Q1R(2SK134)
- ⑦ To 3, REGULATOR/PROTECTOR PC BOARD
- ⑧ To SOURCE, Q1R(2SK134)
- ⑨ ⑩ ⑪ TEST POINTS
- ⑫ To 10, REGULATOR/PROTECTOR PC BOARD
- ⑬ To BUS BAR
- ⑭ To SOURCE, Q2R(2SJ49)
- ⑮ To GATE, Q2R(2SJ49)
- ⑯ To -, C5(10000MF, 70WV)  
To DRAIN, Q2R(2SJ49)
- ⑰ To 5, REGULATOR/PROTECTOR PC BOARD

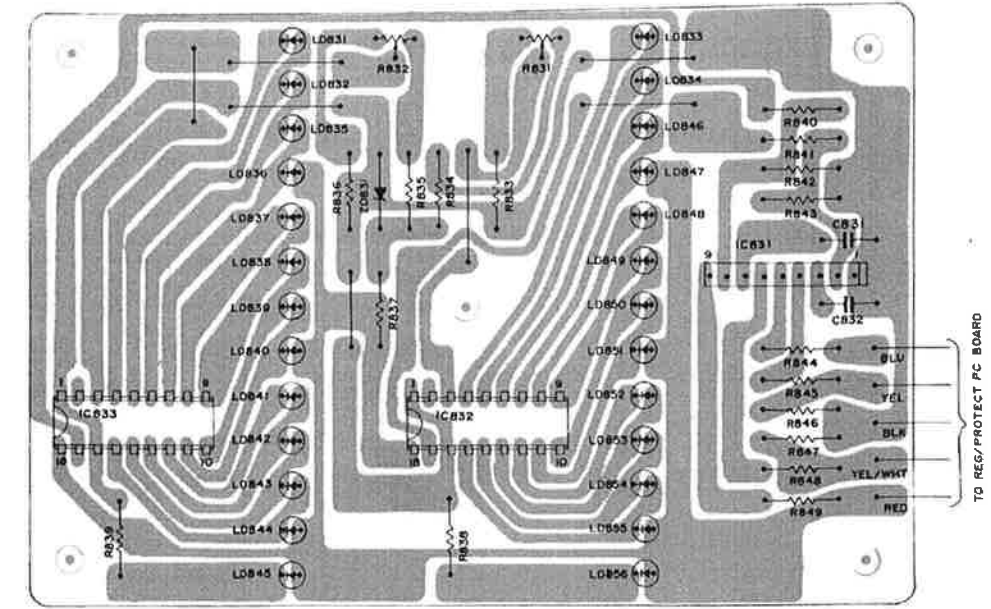
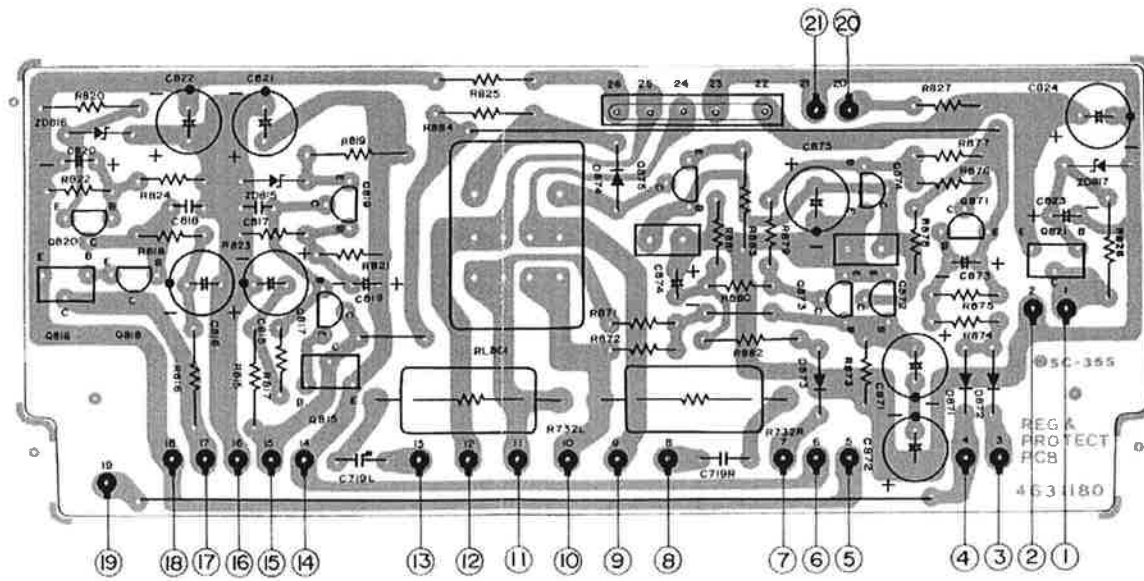
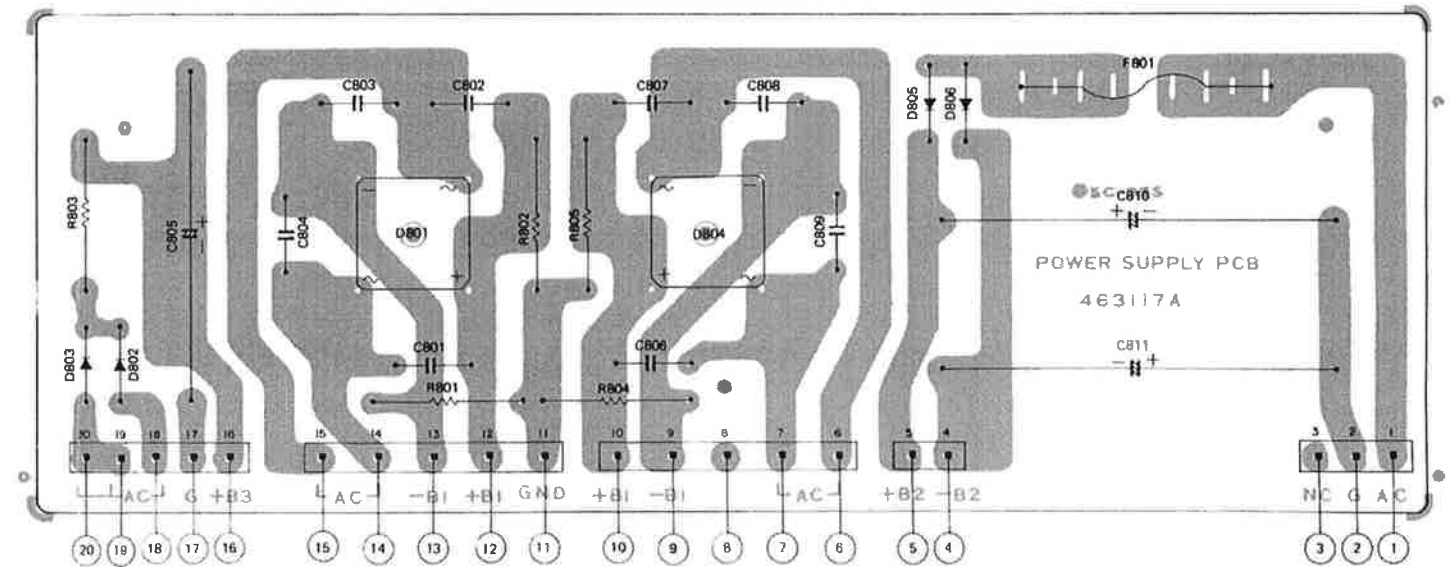

Figure 10. Level Indicator PC Board (Bottom View)



- ① To 16, POWER SUPPLY PC BOARD
- ② To RIGHT CHANNEL BUS
- ③ To 7, RIGHT CHANNEL MAIN AMP PC BOARD
- ④ To 17, RIGHT CHANNEL MAIN AMP PC BOARD
- ⑤ To 4, RIGHT CHANNEL MAIN AMP PC BOARD
- ⑥ To 20, POWER SUPPLY PC BOARD
- ⑦ To 16, POWER SUPPLY PC BOARD
- ⑧ To R -, SPEAKER TERMINAL
- ⑨ To R +, SPEAKER TERMINAL
- ⑩ To 12, RIGHT CHANNEL MAIN AMP PC BOARD
- ⑪ To 12, LEFT CHANNEL MAIN AMP PC BOARD
- ⑫ To L +, SPEAKER TERMINAL
- ⑬ To L -, SPEAKER TERMINAL
- ⑭ To 4, LEFT CHANNEL MAIN AMP PC BOARD
- ⑮ To 5, POWER SUPPLY PC BOARD
- ⑯ To 17, LEFT CHANNEL MAIN AMP PC BOARD
- ⑰ To 7, LEFT CHANNEL MAIN AMP PC BOARD
- ⑱ To 7, LEFT CHANNEL MAIN AMP PC BOARD
- ⑲ To 7, LEFT CHANNEL MAIN AMP PC BOARD
- ⑳ ㉑ To LED SOCKET
- ㉒ ㉓ ㉔ ㉕ ㉖ To LEVEL INDICATOR PC BOARD

Figure 11. Regulator/Protector PC Board (Bottom View)



- ① To RIGHT CHANNEL POWER TRANSFORMER (ORG)
- ② To RIGHT CHANNEL BUS
- ③ To RIGHT CHANNEL POWER TRANSFORMER (BLU)
- ④ To 17, REGULATOR/PROTECTOR PC BOARD
- ⑤ To 15, REGULATOR/PROTECTOR PC BOARD
- ⑥ ⑦ To RIGHT CHANNEL POWER TRANSFORMER (WHT)
- ⑧ To -, C5(10000MF, 70WV)
- ⑨ To +, C3(10000MF, 70WV)
- ⑩ To LEFT CHANNEL BUS
- ⑪ To LEFT CHANNEL BUS
- ⑫ To +, C2(10000MF, 70WV)
- ⑬ To -, C4(10000MF, 70WV)
- ⑭ ⑮ To LEFT CHANNEL POWER TRANSFORMER (WHT)
- ⑯ To 1, REGULATOR/PROTECTOR PC BOARD
- ⑰ To LEFT CHANNEL BUS
- ⑱ To FUSE HOLDER
- ⑲ To FUSE HOLDER
- ⑳ To 7, REGULATOR/PROTECTOR PC BOARD

Figure 12. Power Supply PC Board (Bottom View)

# PARTS LOCATION

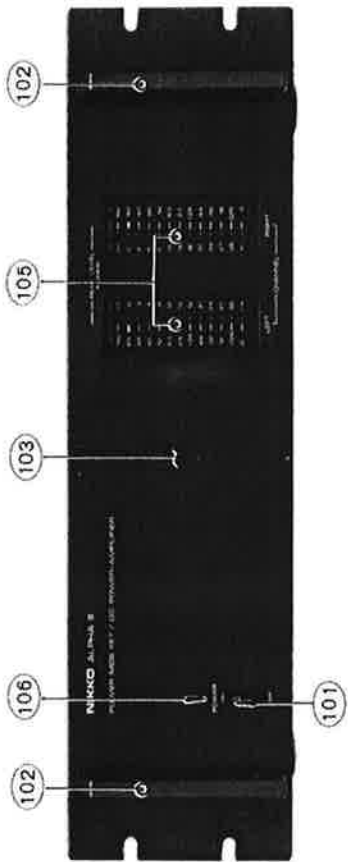

Photo 6.

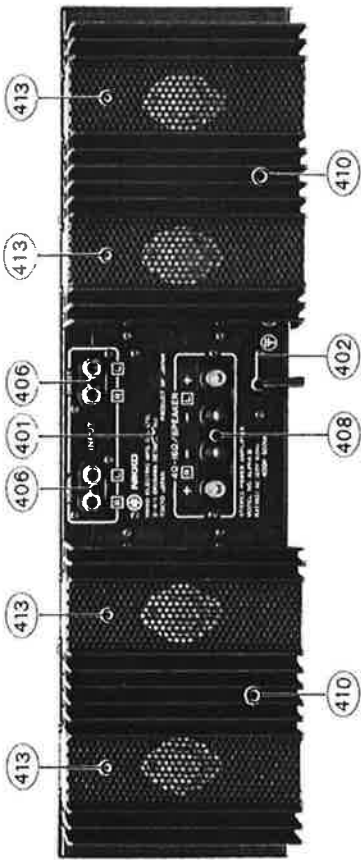

Photo 7.

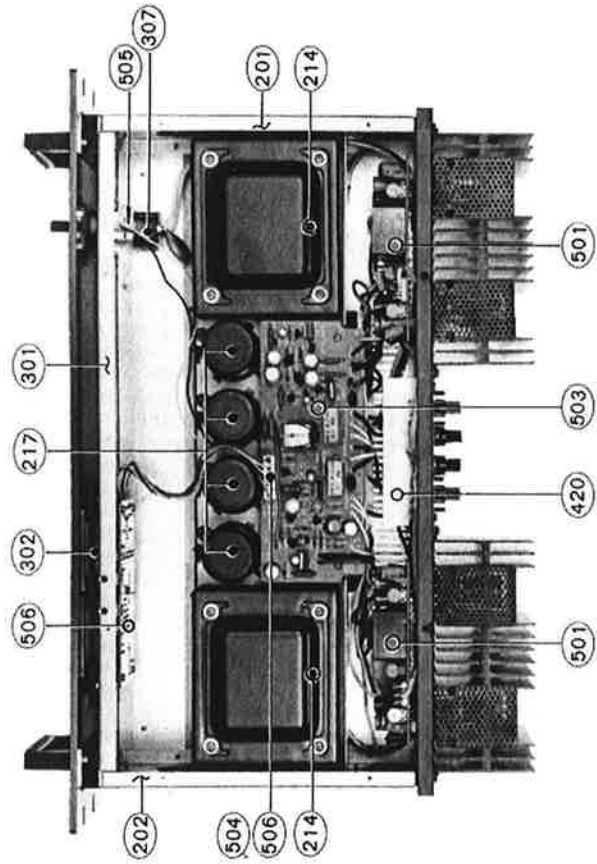

Photo 8.

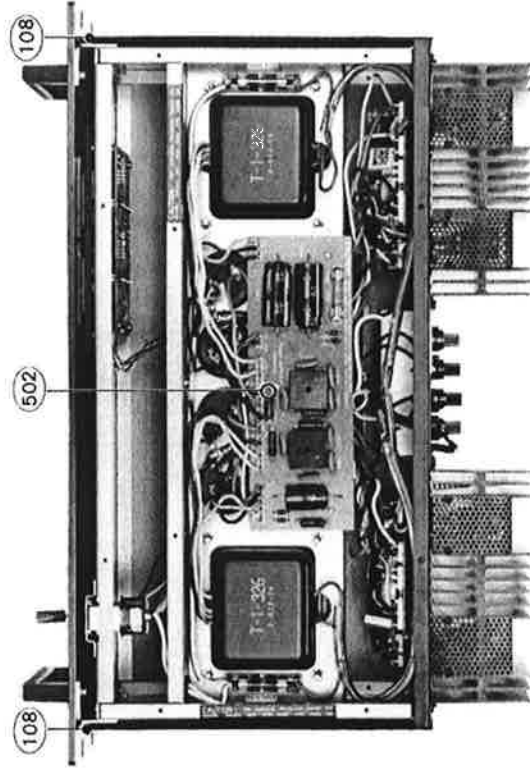

Photo 9.

# PARTS LIST

## NOTES:

1. ★ The KEY NUMBER (#) marked with a (★) on parts list relate to numbers of three digits with a (○). (Photo 6 - 9).
2. + Numerals in file indicate the quantity of parts used in one type.
3. ++ FET: Field effect transistor  
IC: Integrated circuit  
VR: Volume control (Variable resistor)  
RES: Carbon film fixed resistor  
MO-RES: Metal oxide film fixed resistor  
CEM-RES: Cemented wirewound fixed resistor  
NF: Nonflammable  
C-CAP: Ceramic capacitor  
E-CAP: Aluminium electrolytic capacitor  
M-CAP: Polyester film capacitor  
S-CAP: Polystyrene film capacitor.

T-CAP: Tantalum electrolytic capacitor  
BP-CAP: Bipolar electrolytic capacitor

E-CAP, T-CAP and BP-CAP values (1 x 10uf) are in (1) uF, (10) WV.

4. Assemblies and parts are subject to change without notice.
5. Parts ordering procedure:
  - A. DO NOT USE THE "KEY" NUMBER AND "SYMBOL" NUMBER. (these are control # for the factory only.)
  - B. Include in any order.
    - a. Part number.
    - b. Part description.
    - c. Model number.
 (any of the above lacking from an order may delay shipment of that order.)

KEY NO.	SYMBOL NO.	TYPE+	DESCRIPTION++	PART NO.
		W-type-u E-type-n Z-type-d D-type-g		
<b>PACKING MATERIALS &amp; ACCESSORIES</b>				
001		1 1 1 1	Carton	9825390
002		2 2 2 2	Pad	9840870
003		1 1 1 1	Sack, polyethylene cloth	9640660
004		1 1 1 1	Dryer, SILICA GEL	9690010
005		1 1 1 1	Sack (#13), polyethylene cloth	9640320
006a		1 - - - -	Manual (E), instruction	960240E
006b			Manual (SEI), instruction	960261F
006c		- 1 1 - -	Manual (KI), instruction	960241K
006d		- - - 1	Manual (G), instruction	960242G
007		1 1 1 1	Cloth, polishing	9690040
008		1 1 1 1	Cord 2T-1 (NK), phono pin plug	962014A
<b>CABINET ASSEMBLY</b>				
101a		1 1 1 1	Knob, tab type, 15GL-8LS-POWER ◀GOLD MODEL▶	7841110
★101b		1 1 1 1	Knob, tab type, 15BK-8LS-POWER ◀BLACK MODEL▶	7841120
102a		1 1 1 1	Handle(100G)-◀GOLD MODEL▶	7890180
★102b		1 1 1 1	Handle(100B)-◀BLACK MODEL▶	7490190
103a		1 1 1 1	Panel(G), front-◀GOLD MODEL▶	7884080
★103b		1 1 1 -	Panel(BW), front-◀BLACK MODEL▶	7884100
103c		- - - 1	Panel(BY), front-◀BLACK MODEL▶	
104		1 1 1 1	Cloth.DUST COV-for power switch	7001760
★105		2 2 2 2	Window, LED display smoka	7802310
★106		1 1 1 1	LED. GD-4-207RD-POWER	506001S
107		1 1 1 1	Holder, LED	7903060
★108		2 2 2 2	Bracket, panel	7031250
109		6 6 6 6	Screw. PTS 3φ x 8	814308S
110		4 4 4 4	Screw. PMS 5φ x 14	810514S
111		4 4 4 4	Washer, TW(I) 5φ	893405U
112a		1 - - - -	Cover, metal	7820780
112b		- 1 1 1	Cover (D), metal	7820790
113		4 4 4 4	Screw. TFTS 4φ x 10 BLK	887410W
114		4 4 4 4	Washer. W 4φ BLK	893104W
115		4 4 4 4	Screw. PTS 3φ x 6 BLK	814306W
116		1 1 1 1	Plate, bottom	7324650

KEY NO.	SYMBOL NO.	TYPE+	DESCRIPTION++	PART NO.
		W-type-u E-type-n Z-type-d D-type-g		
117		10101010	Screw. PTS 3φ x 6	814306S
118		4 4 4 4	Foot (TG)	7401350
119		4 4 4 4	Screw. PTS 3φ x 8	814308S
<b>CHASSIS ASSEMBLY</b>				
★201		1 1 1 1	Angle, left side	7226250
★202		1 1 1 1	Angle, right side	7226240
203		10101010	Screw. PTS 3φ x 6	814306S
★204		1 1 1 1	Chassis	7325080
205		2 2 2 2	Lug, solder	4400000
206		1 1 1 1	Screw. PTS 3φ x 6	814306S
207		1 1 1 1	Washer. TW(I) 3φ	893403U
208		1 1 1 1	Stay-for REG/PROTECT PCB	7032050
209		2 2 2 2	Screw. PTS 3φ x 6	814306S
210		3 3 3 3	Clip(43), wire	7401340
211		1 1 1 1	Bushing, snap plastic	7401090
212		1 1 1 1	Bushing(43), snap plastic	7401100
213		4 4 4 4	Spacer, rubber-for POWER SUPPLY PCB	4581590
★214a		2 - - - -	Transformer, power. T-1-326- 120V only	1103260
214b		- 2 2 - -	Transformer, power. T-1-327- 220/240V	1103270
215		4 4 4 4	Nut, 1N 4φ	892014S
216		4 4 4 4	Washer. TW(I) 4φ	893404U
★217	C3~C6	4 4 4 4	E-CAP 70R10000uf	212950S
218		8 8 8 8	Screw. BLTS 3φ x 6	874306S
219		2 2 2 2	Bus Bar	7050470
220		2 2 2 2	Strip(4P WP), wire wrap terminal	4400100
221		2 2 2 2	Screw. PTS 3φ x 6	814306S
222		2 2 2 2	Washer. TW(I) 3φ	893403U
223a	F1,F2	2 - - - -	Fuse. 5 amp (250V)	4700540
224a		2 - - - -	Holder, fuse	4581840
225a		2 - - - -	Screw. PTS 3φ x 8	814308S
223b	F1,F2	- 2 2 2	Fuse, midget. 3.15 amp (250V)-time-lag	4720390
224b		- 2 2 2	Holder, midget fuse	4581430
225b		- 2 2 2	Screw. PTS 3φ x 6	814308S
226		6 6 6 6	(Front Plate Assembly) Screw. PTS 3φ x 6 (Back Plate Assembly)	814306S
227		6 6 6 6	Screw. PTS 3φ x 6 BLK	814306W

**PART ORDERING PROCEDURE**-----A. DO NOT USE THE "KEY" NUMBER AND "SYMBOL" NUMBER. (these are control # for the factory only)  
 B. Include in any order: a. Part number, b. Part description, c. Model number, (any of the above lacking from an order may delay shipment of that order.)

KEY NO.	SYMBOL NO.	TYPE+ W-type Z-type D-type	DESCRIPTION++	PART NO.
			(RET/PROTECT PCB)	
229		2 2 2 2	Screw, PTS 3φ x 6 (POWER SUPPLY PCB)	814306S
229		3 3 3 3	Supporter, PC board, LCBS-4	7401540

KEY NO.	SYMBOL NO.	TYPE+ W-type Z-type D-type	DESCRIPTION++	PART NO.
419		8 8 8 8	Washer, TW(II) 3φ	893403U
★420		1 1 1 1	Plate, shield	7032020
421		2 2 2 2	Screw, PTS 3φ x 6	814306W
422		2 2 2 2	Lug(A4), solder	4400110
423		4 4 4 4	Bushing, plastic snap	7401090
424		4 4 4 4	Clip(43), wire (MAIN AMP PCB)	7401340
425		8 8 8 8	Supporter (LCBS-9), PCB	7401310

**FRONT PLATE ASSEMBLY**

★301		1 1 1 1	Plate, front	7325090
★302		1 1 1 1	Panel, LED display plastic, PCB HOLD	7870360
303		4 4 4 4	Screw, PTS 3φ x 8 (LEVEL IND PCB)	814308S
304		5 5 5 5	Screw, PTS 3φ x 10	814310S
305		1 1 1 1	Bracket, lever switch	7031260
306		2 2 2 2	Screw, PTS 3φ x 6	814306S
★307	S1	1 ---	Switch, lever, PJ4AA-POWER	4025410
308	S1	- 1 1 1	Switch, lever, SY02-80DV-POWER	4025150
309		2 2 2 2	Screw, PMS 3φ x 6	810306S
310	C1	1 ---	C-CAP 0.0047uf AC125V	239472C
311		1 ---	Cover(23φ), C-CAP	7400980
312a	F3,F4	2 ---	Fuse, 0.2amp (250V)	4700670
313a		2 ---	Holder, fuse	4581840
314a		2 ---	Screw, PTS 3φ x 8	814308S
312b	F3,F4	- 2 2 2	Fuse, midget 0.2amp (250V)-time-lag	4720440
313b		- 2 2 2	Holder, midget fuse	4581430
314b		- 2 2 2	Screw, PTS 3φ x 6	814308S

**BACK PLATE ASSEMBLY**

★401a		1 ---	Plate (W), back	7325100
401b		- 1 1 -	Plate (EN), back	7325110
401c		--- 1 -	Plate (D), back	
★402a		1 ---	Cord, AC line, DP-70	606009A
402b		- 1 1 1	Cord, AC line, CEE-2T	600510A
403a		1 ---	Stopper, cord, SR-3P-4	7400620
403b		- 1 1 1	Stopper, cord, SR-4N-4	7400690
404a		1 ---	Bracket (UL), cord stopper	7029300
404b		- 1 1 1	Bracket (EH), cord stopper	7029800
405		2 2 2 2	Screw, PTS 3φ x 6 BLK	814306W
★406		2 2 2 2	Terminal, pin jack, WP-2P(CE)- NORMAL/DIRECT INPUT	4442010
407		4 4 4 4	Screw, PMS 3φ x 8 BLK	814308W
★408		1 1 1 1	Terminal, speaker, SCW-4P(NK)	4450480
409		2 2 2 2	Screw, PTS 3φ x 10 BLK	814310W
★410		2 2 2 2	Heat Sink	7480330
411		8 8 8 8	Screw, PTS 3φ x 8	814308W
412		8 8 8 8	Washer, W 3φ	893103S
★413		4 4 4 4	Cover, power FET	7226280
414		16161616	Screw, PTS 3φ x 6	814306W
415	Q1L,Q1R	2 2 2 2	Power FET, 2SK134	516027S
416	Q2L,Q2R	2 2 2 2	Power FET, 2SJ49	517002S
417		4 4 4 4	Socket, power transistor	4510080
418		8 8 8 8	Screw, PMS 3φ x 16	810316S

**MAIN AMP PC BOARD-Left Channel Only**

★501a		1 ---	PC Board, complete, MAIN AMP PCB ASSY	9430700
501b		- 1 1 -	PC Board, complete, MAIN AMP PCB ASSY	
501c		--- 1 -	PC Board, complete, MAIN AMP PCB ASSY	
	C701L	1 1 1 1	E-CAP 50R3.3uf CE-NUM	211513A
	C702L	1 1 1 1	E-CAP 50R10uf	211520Q
	C703L	1 1 1 1	C-CAP 47pf 10% 50V SL	232470K
	C704L	1 1 1 1	C-CAP 7pf ±0.5pf 50V SL	234709D
	C705L	1 1 1 1	E-CAP 10R220uf CE-NUM	211132A
	C706L	1 1 1 1	C-CAP 4pf ±0.5pf 500V SL	234409D
	C707L	1 1 1 1	C-CAP 4pf ±0.5pf 500V SL	234409D
	C708L	1 1 1 1	E-CAP 10R220uf CE-NUM	211132A
	C709L	1 1 1 1	E-CAP 63R22uf	211622Q
	C710L	1 1 1 1	M-CAP 0.068uf 10% 100V	226683K
	C711L	1 1 1 1	E-CAP 63R22uf	211622Q
	C712L	1 1 1 1	M-CAP 0.068uf 10% 100V	226683K
	C713L	1 1 1 1	E-CAP 100R22uf	211822Q
	C714L	1 1 1 1	M-CAP 0.22uf 10% 100V	226224K
	C715L	1 1 1 1	E-CAP 100R22uf	211822Q
	C716L	1 1 1 1	M-CAP 0.22uf 10% 100V	226224K
	C717L	1 1 1 1	M-CAP 0.047uf 10% 200V	272473K
		1 1 1 1	C-CAP 10pf 10% 500V	234100K
	D701L			
	~D704L	4 4 4 4	Diode, 1S2076-light blue	501019S
	D705L			
	~D707L	3 3 3 3	Diode, 1S2076A-navy blue	501020S
	L701L	1 1 1 1	Coil, 0.5uh	1210900
	Q701L	1 1 1 1	Transistor, 2SB716(D,E)	511102S
	Q702L	1 1 1 1	Transistor, 2SD756(D,E)	513102S
	Q703L	1 1 1 1	Transistor, 2SC2088(BL)	511023S
	R701L	1 1 1 1	RES 470kohm 5% 1/4W	328474J
	R702L	1 1 1 1	RES 39kohm 5% 1/4W	328393J
	R703L	1 1 1 1	Potentiometer, B1kohm-HVR-RVA- 0911H	4300910
	R704L	1 1 1 1	RES 39kohm 5% 1/4W	328393J
	R705L	1 1 1 1	RES 1kohm 5% 1/4W	328102J
	R706L	1 1 1 1	RES 56kohm 5% 1/4W	328563J
	R707L	1 1 1 1	RES 2.2kohm 5% 1/4W	328222J
	R708L	1 1 1 1	RES 470kohm 5% 1/4W	328474J
	R709L	1 1 1 1	RES 470ohm 5% 1/4W	328471J
	R710L	1 1 1 1	RES 56kohm 5% 1/4W	328563J
	R711L	1 1 1 1	RES 47kohm 5% 1/4W	328473J
	R712L	1 1 1 1	Potentiometer, B22kohm-HVR.	



**PART ORDERING PROCEDURE** ----- A. DO NOT USE THE "KEY" NUMBER AND "SYMBOL" NUMBER, (these are control # for the factory only)  
 B. Include in any order: a. Part number, b. Part description, c. Model number, (any of the above lacking from an order may delay shipment of that order.)

KEY NO.	SYMBOL NO.	TYPE+ W Z D	DESCRIPTION++	PART NO.	KEY NO.	SYMBOL NO.	TYPE+ W Z D	DESCRIPTION++	PART NO.
			RVA-0911H	4300990					
	R713L	1 1 1 1	RES 8.2kohm 5% 1/4W	328822J					
	R714L	1 1 1 1	RES 8.2kohm 5% 1/4W	328822J					
	R715L	1 1 1 1	RES 8.2kohm 5% 1/4W	328822J					
	R716L	1 1 1 1	RES 8.2kohm 5% 1/4W	328822J					
	R717L	1 1 1 1	RES 1kohm 5% 1/4W	328102J					
	R718L	1 1 1 1	RES 1kohm 5% 1/4W	328102J					
	R719L	1 1 1 1	RES 12kohm 5% 1/4W	328123J					
	R720L	1 1 1 1	NF-MO-RES 470ohm 5% 1/2W	360471L					
	R721L	1 1 1 1	Potentiometer. B1kohm-HVR. RVA-0911H	4300910					
	R722L	1 1 1 1	RES 220ohm 5% 1/4W	328221J					
	R723L	1 1 1 1	NF-MO-RES 470ohm 5% 1/2W	360471L					
	R724L	1 1 1 1	RES 220ohm 5% 1/4W	328221J					
	R725L	1 1 1 1	RES 150ohm 5% 1/4W	328151J					
	R726L	1 1 1 1	CEM-RES 0.22ohm 10% 5W	384229W					
	R727L	1 1 1 1	CEM-RES 0.22ohm 10% 5W	384229W					
	R728L	1 1 1 1	CEM-RES 3.3ohm 10% 5W	384338K					
	R729L	1 1 1 1	RES 2.2kohm 5% 1/4W	328222J					
	R730	1 1 1 1	RES 33kohm 5% 1/4W	328333J					
	R731L	1 1 1 1	NF-MO-RES 4.7ohm 5% 2W	362478L					
	U701L	1 1 1 1 (2 2 2 2) (2 2 2 2)	Amp. COMP DIF AMP ASSY Transistor. 2SC1775(E) Transistor. 2SA872(E)	518068S 511015S 510043S					
	ZD701L	1 1 1 1	Zener Diode. XZ122	502020S					
	ZD702L	1 1 1 1	Zener Diode. XZ122	502020S					
<b>POWER SUPPLY PC BOARD</b>									
★502a	1 ---		PC Board, complete. POWER SUPPLY PCB ASSY	9450800					
502b	- 1 1 1		PC Board, complete. POWER SUPPLY PCB ASSY	9450850					
	C801								
	~C804	4 4 4 4	C-CAP 0.01uf 100, -0% 500V	238103P					
	C805	1 1 1 1	E-CAP 50T470uf	211535U					
	C806								
	~C809	4 4 4 4	C-CAP 0.01uf 100, -0% 500V	238103P					
	C810	1 1 1 1	E-CAP 100T470uf	211835U					
	C811	1 1 1 1	E-CAP 100T470uf	211835U					
	D801	1 1 1 1	Diode, bridge. S5VB20	560042S					
	D802	1 1 1 1	Diode. S5277B	560046S					
	D803		-DELETED-						
	D804	1 1 1 1	Diode, bridge. S5VB20	560042S					
	D805	1 1 1 1	Diode. S5277D	560047S					
	D806	1 1 1 1	Diode. S5277D	560047S					
	F801	1 --- 2 ---	Fuse, 2A(125V) Clip, fuse	4700660 7050420					
	F801	- 1 1 1 - 2 2 2	Fuse, midget. 2AT(250V)-time lag Clip, midget fuse	4720370 7050430					
	R801	1 1 1 1	NF-MO-RES 10kohm 5% 2W	362103L					
	R802	1 1 1 1	NF-MO-RES 10kohm 5% 2W	362103L					
	R803	1 1 1 1	NF-MO-RES 56ohm 5% 2W	362560L					
	R804	1 1 1 1	NF-MO-RES 10kohm 5% 2W	362103L					
	R805	1 1 1 1	NF-MO-RES 10kohm 5% 2W	362103L					
<b>REGULATOR/PROTECTOR PC BOARD</b>									
	★503a	1 ---	PC Board, complete. REG/PROTECT PCB ASSY (W)	9450810					
	503b	- 1 1 -	PC Board, complete. REG/PROTECT PCB ASSY (EN)						
	503C	--- 1	PC Board, complete. REG/PROTECT PCB ASSY (D)						
	C719L	1 1 1 1	M-CAP 0.047uf 10% 200V	272473K					
	C719R	1 1 1 1	M-CAP 0.047uf 10% 200V	272473K					
	C815	1 1 1 1	E-CAP 100R22uf	211822D					
	C816	1 1 1 1	E-CAP 100R22uf	211822Q					
	C817	1 1 1 1	M-CAP 0.01uf 10% 100V	226103K					
	C818	1 1 1 1	M-CAP 0.01uf 10% 100V	226103K					
	C819	1 1 1 1	E-CAP 50R3.3uf	211513Q					
	C820	1 1 1 1	E-CAP 50R3.3uf	211513Q					
	C821	1 1 1 1	E-CAP 63R22uf	211622Q					
	C822	1 1 1 1	E-CAP 63R22uf	211622Q					
	C823	1 1 1 1	E-CAP 16R22uf	211223Q					
	C824	1 1 1 1	E-CAP 16R100uf	211223Q					
	C871	1 1 1 1	E-CAP 63R220uf	211032Q					
	C872	1 1 1 1	E-CAP 63R220uf	211032Q					
	C873	1 1 1 1	E-CAP 50R0.47uf	211505Q					
	C874	1 1 1 1	E-CAP 50R3.3uf	211513Q					
	C875	1 1 1 1	E-CAP 35R100uf	211430Q					
	D871	1 1 1 1	Diode. 1S2076-light blue	501019S					
	D872	1 1 1 1	Diode. 1S2076-light blue	501019S					
	D873	1 1 1 1	Diode. 1S2076A-navy blue	501020S					
	D874	1 1 1 1	Diode. 1S2076A-navy blue	501020S					
	Q815	1 1 1 1	Transistor. 2SD381(L,M)	510038S					
	Q816	1 1 1 1	Transistor. 2SB536(L,M)	510039S					
	Q817	1 1 1 1	Transistor. 2SC208B(BL)	510023S					
	Q818	1 1 1 1	Transistor. 2SA941(BL)	510048S					
	Q819	1 1 1 1	Transistor. 2SC945L(P,Q)	515077S					
	Q820	1 1 1 1	Transistor. 2SC945L(P,Q)	515077S					
	Q821	1 1 1 1	Transistor. 2SD381(L,M)	510038S					
	Q871	1 1 1 1	Transistor. 2SA733(Q,R)	514074S					
	Q872	1 1 1 1	Transistor. 2SC945L(P,Q)	515077S					
	Q873	1 1 1 1	Transistor. 2SA733(Q,R)	514074S					
	Q874	1 1 1 1	Transistor. 2SC945L(P,Q)	515077S					
	Q875	1 1 1 1	Transistor. 2SC1627(Y)	511017S					
	R732L	1 1 1 1	CEM-RES 3.9ohm 10% 5W	384398K					
	R732R	1 1 1 1	CEM-RES 3.9ohm 10% 5W	384398K					
	R815	1 1 1 1	NF-MO-RES 4.7kohm 5% 1/2W	360472L					
	R816	1 1 1 1	NF-MO-RES 4.7kohm 5% 1/2W	360472L					
	R817	1 1 1 1	RES 10kohm 5% 1/4W	328103J					
	R818	1 1 1 1	RES 10kohm 5% 1/4W	328103J					
	R819	1 1 1 1	NF-MO-RES 15kohm 5% 1/2W	360153L					
	R820	1 1 1 1	RES 15kohm 5% 1/4W	328153J					
	R821	1 1 1 1	RES 33kohm 5% 1/4W	328333J					
	R822	1 1 1 1	RES 33kohm 5% 1/4W	328333J					
	R823	1 1 1 1	RES 22kohm 5% 1/4W	328223J					
	R824	1 1 1 1	RES 22kohm 5% 1/4W	328223J					
	R825	1 1 1 1	NF-MO-RES 4.7kohm 5% 1W	361472L					
	R826	1 1 1 1	NF-MO-RES 2.2kohm 5% 1W	361222L					
	R827	1 1 1 1	RES 1.2kohm 5% 1/4W	328122J					
	R871	1 1 1 1	RES 27kohm 5% 1/4W	328273J					
	R872	1 1 1 1	RES 27kohm 5% 1/4W	328273J					

**PART ORDERING PROCEDURE**----- A. DO NOT USE THE "KEY" NUMBER AND "SYMBOL" NUMBER. (these are control # for the factory only)  
 B. Include in any order: a. Part number, b. Part description, c. Model number. (any of the above lacking from an order may delay shipment of that order.)

KEY NO.	SYMBOL NO.	TYPE+ W-type E-type N-type D-type	DESCRIPTION++	PART NO.
	R873	1 1 1 1	RES 47kohm 5% 1/4W	328473J
	R874	1 1 1 1	RES 47kohm 5% 1/4W	328473J
	R875	1 1 1 1	RES 100kohm 5% 1/4W	328104J
	R876	1 1 1 1	RES 68kohm 5% 1/4W	328683J
	R877	1 1 1 1	RES 180kohm 5% 1/4W	328184J
	R878	1 1 1 1	RES 100kohm 5% 1/4W	328104J
	R879	1 1 1 1	RES 15kohm 5% 1/4W	328153J
	R880	1 1 1 1	RES 22kohm 5% 1/4W	328223J
	R881	1 1 1 1	RES 18kohm 5% 1/4W	328183J
	R882	1 1 1 1	NF-MO-RES 3.3kohm 5% 1/2W	360332L
	R883	1 1 1 1	NF-MO-RES 680ohm 5% 1W	361681L
	R884	1 1 1 1	NF-MO-RES 680ohm 5% 1W	361681L
	RL801	1 1 1 1	Relay. MAT4B211R 24V	1700210
	ZD815	1 1 1 1	Zener Diode. XZ225	502036S
	ZD816	1 1 1 1	Zener Diode. XZ225	502036S
	ZD817	1 1 1 1	Zener Diode. WZ137	502037S
★504		1 1 1 1	Connector, 5-pin female--for LEVEL IND PCB	4570130
★505		1 1 1 1	Socket(3021-2-N), LED cable	4510090
<b>LEVEL INDICATOR PC BOARD</b>				
★506a		1 1 1 1	PC Board, complete. LEVEL IND PCB ASSY	9492640
506b			PC Board, complete. LEVEL IND PCB ASSY	

KEY NO.	SYMBOL NO.	TYPE+ W-type E-type N-type D-type	DESCRIPTION++	PART NO.
	C831	1 1 1 1	M-CAP 0.015uf 10% 50V	222153K
	C832	1 1 1 1	M-CAP 0.015uf 10% 50V	222163K
	IC831	1 1 1 1	IC. TA7318P	518067S
	IC832	1 1 1 1	IC. UAA180	518066S
	IC833	1 1 1 1	IC. UAA180	518066S
	LD831			
	~LD834	4 4 4 4	LED. SLP135B--red	5060120
	LD835			
	~LD856	11111111	LED. SLP235B--green	5060110
	R831	1 1 1 1	Potentiometer. B3.3kohm--HVR- RVA-0911H	4300940
	R832	1 1 1 1	Potentiometer. B3.3kohm--HVR- RVA-0911H	4300940
	R833	1 1 1 1	RES 1kohm 5% 1/4W	328102J
	R834	1 1 1 1	RES 15kohm 5% 1/4W	328153J
	R835	1 1 1 1	RES 15kohm 5% 1/4W	328153J
	R836	1 1 1 1	RES 1kohm 5% 1/5W	328102J
	R837	1 1 1 1	RES 1kohm 5% 1/4W	328102J
	R838	1 1 1 1	RES 1.2kohm 5% 1/4W	328122J
	R839	1 1 1 1	RES 1.2kohm 5% 1/4W	328122J
	R840	1 1 1 1	RES 100ohm 5% 1/4W	328101J
	R841	1 1 1 1	RES 390ohm 5% 1/4W	328391J
	R842	1 1 1 1	RES 390ohm 5% 1/4W	328391J
	R843	1 1 1 1	RES 390ohm 5% 1/4W	328391J
	R844	1 1 1 1	RES 470ohm 5% 1/4W	328471J
	R845	1 1 1 1	RES 120kohm 5% 1/4W	328124J
	R846	1 1 1 1	RES 10kohm 5% 1/4W	328103J
	R847	1 1 1 1	RES 10kohm 5% 1/4W	328103J
	R848	1 1 1 1	RES 120kohm 5% 1/4W	328124J
	ZD831	1 1 1 1	Zener Diode. WZ069	502035S
★506		1 1 1 1	Connector, 5-pin female--for REG/PROTECT PCB	4570200



## INTEGRATED CIRCUITS TA7318P

### FUNCTION/MANUFACTURER

- Dual Linear-to-Log Converter for Peak Power Indicator/Toshiba

### BLOCK DIAGRAM AND CONNECTION INFORMATION

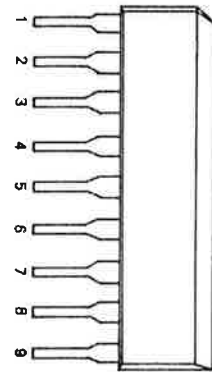
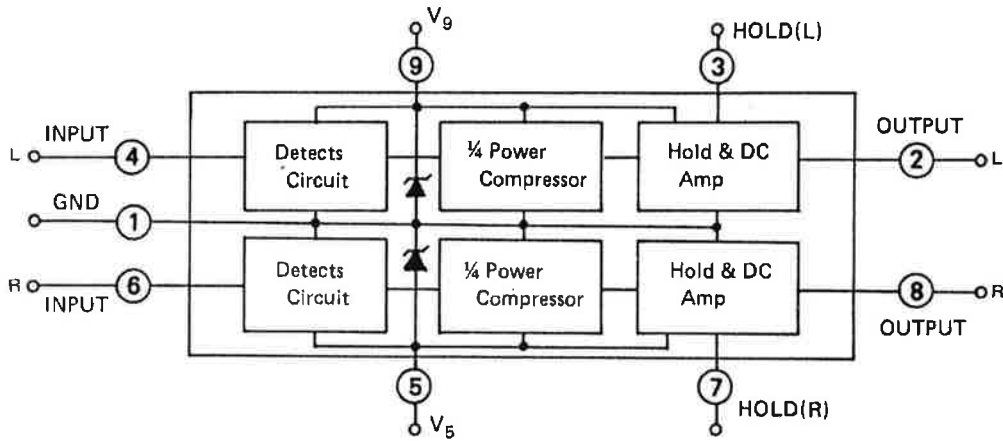

(SIDE VIEW)

## INTEGRATED CIRCUITS UAA180

### FUNCTION/MANUFACTURER

- Analog-to-Digital Converter; 12LED Driver/Siemens

### BLOCK DIAGRAM AND CONNECTION INFORMATION

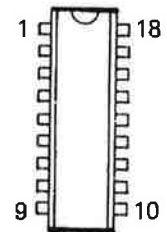
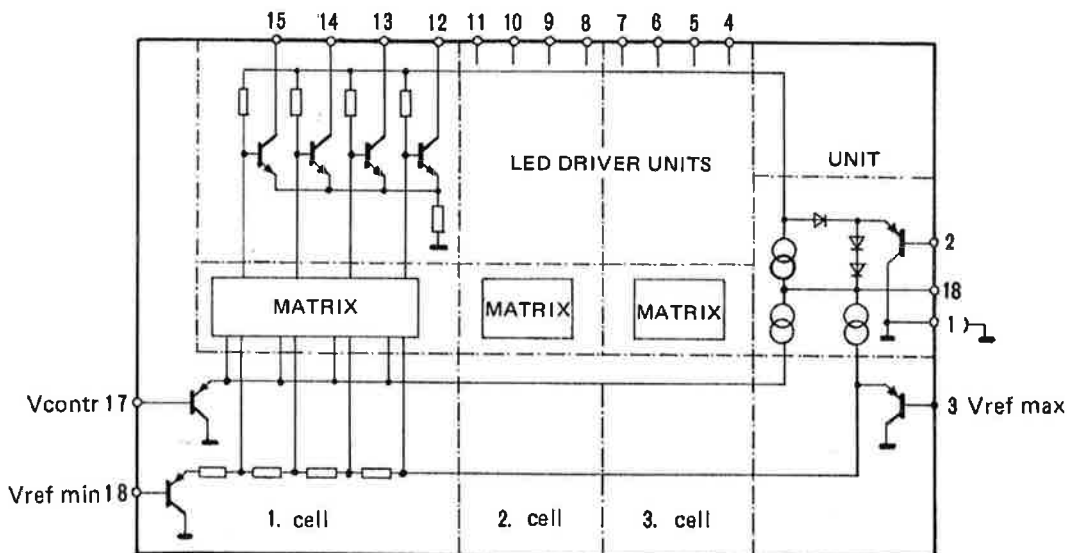

(TOP VIEW)



**NIKKO ELECTRIC MFG. CO., LTD.**

HEAD OFFICE

4-1, Okusawa 3-chome, Setagaya-ku, Tokyo 158, Japan

SALES OFFICE

Mitsubishi Bank Bldg., 3-2, Dogenzaka 1-chome  
Shibuya-ku, Tokyo 150, Japan

**NIKKO ELECTRIC CORP. OF AMERICA**

HEAD OFFICE

16270 Raymer St., Van Nuys, Ca. 91406, U.S.A.

NY OFFICE

218 Sherwood Ave., Farmingdale, NY 11735, U.S.A.